

MITSUBISHI

PROGRAMMABLE CONTROLLER

MELSEC-A

User's Manual

MELSEC-I/O link remote I/O system master module type A1SJ51T64 (Hardware)

INTRODUCTION

Thank you for choosing the Mitsubishi MELSEC A Series of General Purpose Programmable Controllers. Please read this manual carefully so that the equipment is used to its optimum. A copy of this manual should be forwarded to the end User.



IB (NA) 66577-A

1. GENERAL DESCRIPTION

This manual describes the specifications, nomenclature, settings, wiring and programming of the A1SJ51T64 type master module, which is used in a MELSEC-I/O LINK remote I/O system.

The following are the features of the MELSEC-I/O LINK remote I/O system.

- (1) Up to 128 I/O points can be controlled
Using an eight-I/O-point combination module (AJ55TB32-8[]), one master module can control up to 128 I/O points.
- (2) Flexible connections can be made
Since the system requires no terminal resistors, flexible connections using a bus, such as T-branches, can be made.
- (3) Communication errors can be prevented
Because a bus connection is used, the system can continue operating even if an individual station goes down.
- (4) Programming is easy
Programs can be created using only X and Y devices.
- (5) Applicable CPUs
A1SCPU(S1), A1SJCPU, A2SCPU(S1), A2ASCPU(S1), A52GCPU(T21B)

1.1 Related Manuals

- A1SJ51T64 User's Manual (IB-66574)
Gives details of the specifications, functions and programming of the A1SJ51T64.

2. PERFORMANCE SPECIFICATIONS

The following table shows the performance specifications of the A1SJ51T64.

Item	Specification	
Maximum number of controllable I/O points	128 points (when X and Y devices are given the same numbers)	
I/O refresh time	Approx. 5.4 msec (regardless of the number of points)	
Communication cable	Twisted pair cable: 0.75 mm ² or over Cable type: 0.75 mm ² or over	
Communication specifications	Communication speed	38400 BPS
	Communication method	Register insertion method
	Synchronization method	Combination of frame-synchronization and bit synchronization
	Error control system	Parity check
	Transmission channel type	Bus system (T branches possible, no terminal resistors required)
	Transmission distance	Overall distance: 200 m
Number of connectable remote I/O stations	16 stations/master module	
Error (RUN) display/output	LED display Detection using PC CPU "blown fuse" External output using RUN A/RUN B	
Number of occupied I/O points	64 points (I/O allocation: 64 output points) *	
External power supply voltage	21.6 to 27.6 VDC	
External power supply current consumption	90 mA (TYP 24 VDC)	
Current consumption (5 VDC)	115 mA	
Weight kg (lb)	0.3 (0.66)	
Number of usable modules	Any number of modules within the number of PC CPU I/O points can be installed	

- * When the number of stations connected to the remote I/O module is small, the number of points can be reduced to 16, 32 or 48 by I/O allocation with a peripheral device. For the general specifications, refer to the user's manual for the PC CPU used.

The United States	Mitsubishi Electronics America, Inc. (Industrial Automation Division) 800 Biermann Court, Mt. Prospect, IL 60056 Phone: (708)298-9223
Canada	Mitsubishi Electric Sales Canada, Inc. (Industrial Automation Division) 4299 14th Avenue, Markham, Ontario L3R 0J2 Phone: (416)475-7728
United Kingdom	Mitsubishi Electric UK Ltd. (Industrial Sales Division) Travellers Lane, Hatfield, Herts AL10 8XB Phone: (0707)276100
Germany	Mitsubishi Electric Europe GmbH. (Industrial Automation Division) Gothaer Strasse 8, Postfach 1548, D 4030 Ratingen 1 Phone: (02102)4860
Taiwan	Setsuyo Enterprise Co., Ltd., (106) 11th Fl., Chung Ling Bldg. 363 Sec 2 Fu Heing S Rd Taipei Taiwan R.O.C. Phone: (02)732-0161
Hongkong (& China)	Ryoden International Ltd. (Industrial & Electrical Controls Division) 10/F, Manulife Tower, 169 Electric Rd. North Point Hong Kong Phone: 8678870
Singapore (& Malaysia)	MELCO Sales Shingapore Pte. Ltd. (Industrial Division) 307 Alexandra Rd. #05 01/02, Mitsubishi Electric Bldg. Singapore 0315 Phone: 4732308
Thailand	F A Tech Co. Ltd., 1138/33 34 Rama 3 Rd., Yannawa Bangkok 10120 Phone: (02)295-2861-4
Australia	Mitsubishi Electric Australia Pty Ltd. (Industrial Controls Division) 348 Victoria Rd., Rydalmere N.S.W. 2116 Phone: (02)684-7260
Republic of South Africa	M S A Manufacturing (Pty) Ltd. (Factory Automation Division) P.O. Box 39733, Bramley Johannesburg 2018 Phone: (011)444-8080

MITSUBISHI ELECTRIC CORPORATION
HEAD OFFICE: MITSUBISHI DENSO BLDG. 5F MARUNOUCHI 2-CHOME, TOKYO 100, JAPAN
TELEX: 22642 MELCO TOKYO
NAGOYA WORKS: 1-14, TADAURA 4-1, NAGASHIMA, NAGOYA, JAPAN

When exported from Japan, this manual does not require application to the Ministry of International Trade and Industry for service transaction permission.



IB (NA) 66577-A (9/86) FEE Printed in Japan

Specifications subject to change without notice.

3. NOMENCLATURE AND SETTINGS

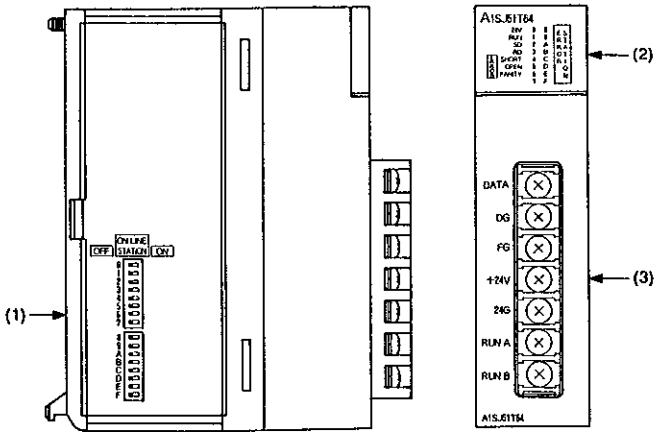
RUN Output (RUN A, RUN B)

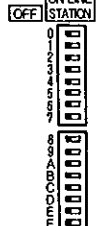
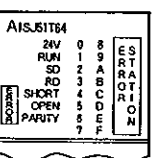

No	Name	Description																			
(1)	ON LINE STATION 	Used to set the station numbers of the remote I/O stations connected (The numbers 0 to F represent the station numbers) ON: Communication possible (error check enabled) OFF: Communication impossible (error check disabled) * Setting the switches for the unconnected stations to OFF can prevent communication errors																			
(2)	LED 	<table border="1"> <thead> <tr> <th>LED Name</th> <th>Description</th> </tr> </thead> <tbody> <tr> <td>24V</td> <td>On: The power supply voltage (24 V) is normal. Off: The power supply voltage (24 V) is insufficient</td> </tr> <tr> <td>RUN</td> <td>On: The data received by all remote I/O modules with the ON LINE STATION switch set to ON is normal Off: A received data error has occurred, or a SHORT, OPEN or PARITY error has occurred (Communication with normal stations continues)</td> </tr> <tr> <td>SD</td> <td>Indicates that data is being transmitted to remote I/O modules</td> </tr> <tr> <td>RD</td> <td>Indicates that data is being received from remote I/O modules (The brightness of the LED varies according to the number of stations)</td> </tr> <tr> <td rowspan="3">ERR</td> <td>SHORT</td> <td>Indicates that there is a short between DATA and DG</td> </tr> <tr> <td>OPEN</td> <td>(1) Transmission channel disconnection (2) Remote I/O module failure and power off</td> </tr> <tr> <td>PARITY</td> <td>Indicates that there is an error in the data received from remote I/O modules</td> </tr> <tr> <td>ERROR STATION</td> <td>0 to F Displays the number(s) of the remote I/O module(s) which cannot communicate data</td> </tr> </tbody> </table>	LED Name	Description	24V	On: The power supply voltage (24 V) is normal. Off: The power supply voltage (24 V) is insufficient	RUN	On: The data received by all remote I/O modules with the ON LINE STATION switch set to ON is normal Off: A received data error has occurred, or a SHORT, OPEN or PARITY error has occurred (Communication with normal stations continues)	SD	Indicates that data is being transmitted to remote I/O modules	RD	Indicates that data is being received from remote I/O modules (The brightness of the LED varies according to the number of stations)	ERR	SHORT	Indicates that there is a short between DATA and DG	OPEN	(1) Transmission channel disconnection (2) Remote I/O module failure and power off	PARITY	Indicates that there is an error in the data received from remote I/O modules	ERROR STATION	0 to F Displays the number(s) of the remote I/O module(s) which cannot communicate data
		LED Name	Description																		
		24V	On: The power supply voltage (24 V) is normal. Off: The power supply voltage (24 V) is insufficient																		
		RUN	On: The data received by all remote I/O modules with the ON LINE STATION switch set to ON is normal Off: A received data error has occurred, or a SHORT, OPEN or PARITY error has occurred (Communication with normal stations continues)																		
		SD	Indicates that data is being transmitted to remote I/O modules																		
		RD	Indicates that data is being received from remote I/O modules (The brightness of the LED varies according to the number of stations)																		
		ERR	SHORT	Indicates that there is a short between DATA and DG																	
OPEN	(1) Transmission channel disconnection (2) Remote I/O module failure and power off																				
PARITY	Indicates that there is an error in the data received from remote I/O modules																				
ERROR STATION	0 to F Displays the number(s) of the remote I/O module(s) which cannot communicate data																				
(3)	Terminal block 	<table border="1"> <thead> <tr> <th>Name</th> <th>Description</th> </tr> </thead> <tbody> <tr> <td>DATA</td> <td>Data</td> </tr> <tr> <td>DG</td> <td>Data ground</td> </tr> <tr> <td>FG</td> <td>Frame ground</td> </tr> <tr> <td>+24V</td> <td>24 V transmission power supply (positive side)</td> </tr> <tr> <td>24G</td> <td>24 V transmission power supply (negative side)</td> </tr> <tr> <td>RUN A RUN B</td> <td>Outputs the on/off status of the RUN LED (RUN output) ON: RUN LED on OFF: RUN LED off</td> </tr> </tbody> </table>	Name	Description	DATA	Data	DG	Data ground	FG	Frame ground	+24V	24 V transmission power supply (positive side)	24G	24 V transmission power supply (negative side)	RUN A RUN B	Outputs the on/off status of the RUN LED (RUN output) ON: RUN LED on OFF: RUN LED off					
		Name	Description																		
		DATA	Data																		
		DG	Data ground																		
		FG	Frame ground																		
		+24V	24 V transmission power supply (positive side)																		
		24G	24 V transmission power supply (negative side)																		
RUN A RUN B	Outputs the on/off status of the RUN LED (RUN output) ON: RUN LED on OFF: RUN LED off																				

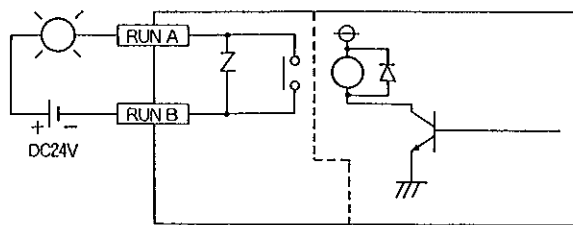
Specifications		
Output type	Contact output	
Insulation method	Relay insulation	
Rated load voltage and current	24 VDC (resistance load), 240 VAC (COSφ = 1) 2 A/point	
Minimum switching load	5 VDC 1mA	
Maximum switching voltage	250 VAC 110 VDC	
Response time	OFF → ON	10 msec or less
	ON → OFF	12 msec or less
Service life	Mechanical	20 million operations minimum
	Electrical	Rated switching voltage and current load: 100,000 operations minimum
		200 VAC and 1.5 A or 240 VAC and 1 A (COSφ = 0.7): 100,000 operations minimum
		200 VAC and 1 A or 240 VAC and 0.5 A (COSφ = 0.35): 100,000 operations minimum
		24 VDC and 1 A or 100 VDC and 0.1 A (L/R = 7 msec): 100,000 operations minimum
Maximum switching frequency	3600 times/hour	
Surge suppressor	Varistor	
External connection		

POINT

The off status of the RUN LED can be confirmed at the PC CPU as the "blown fuse" status

M9000	RUN status (blown fuse detected)
D9000	First I/O number of the master module (number of module with blown fuse)
D9100 to D9107	Number of module with blown fuse (details)

Note The RUN off status does not show which remote I/O module is down

4. CONNECTION WITH REMOTE I/O MODULES

This chapter shows how to connect remote I/O modules to a master module

Remote I/O modules may be connected in random order

(1) Connection using twisted pair cables

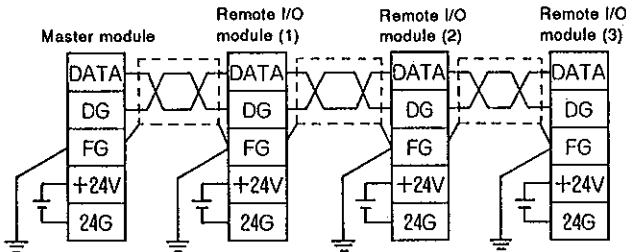

(2) Connection using cabtyre cables

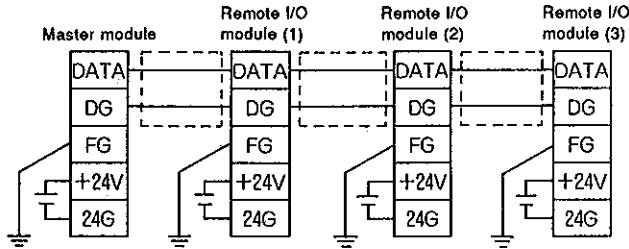

* To supply power to two or more modules with one power supply unit as shown below, connect the modules in such a way that the voltage requirement of each module (15.6 - 27.6 VDC) can be met

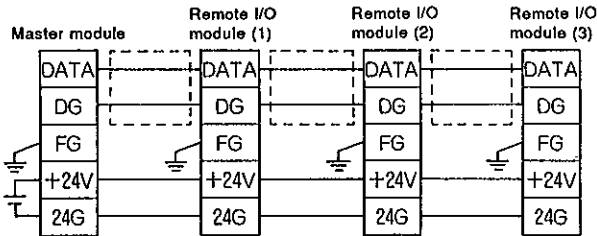

CAUTION

If a voltage of *24 VDC* is applied to the signal lines (DATA, DG) by mistake, the module will be destroyed

Before turning on the external power supply (24 VDC), confirm that the connections are correct

(3) T-branches

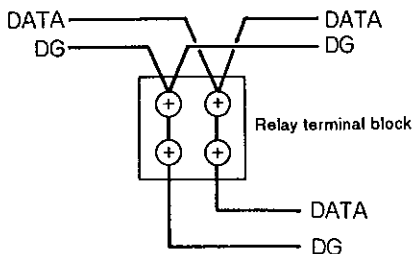

5. PROGRAMMING

X and Y devices are used directly to create a program

The following system example shows the devices used for programming

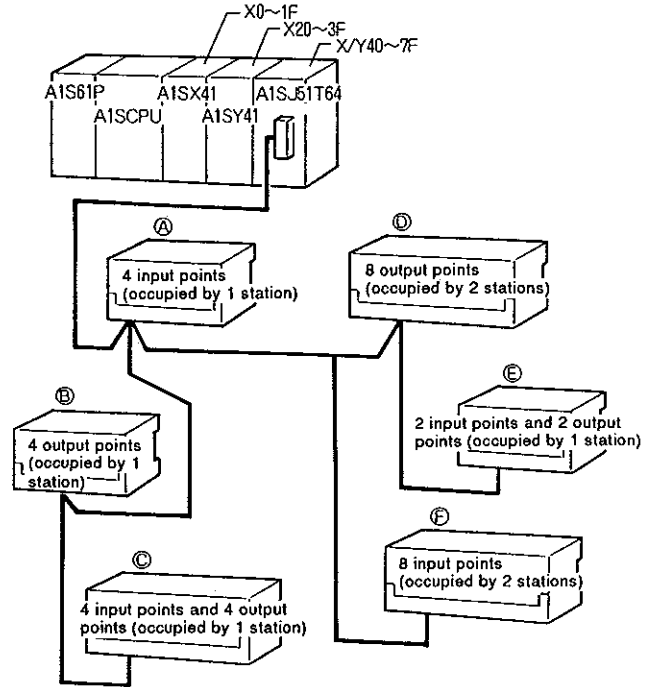

When the station numbers are set in alphabetical order ((A) - (F)), addresses are allocated to the stations as follows

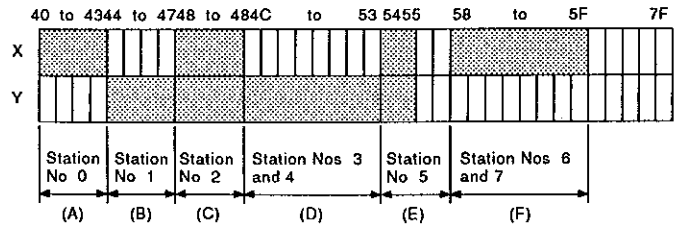

Of the input/output combination modules, "4-point modules" use the first half two points of both X and Y devices
They cannot use the second half two points

6. REMOTE I/O MODULE SPECIFICATIONS

This section gives the specifications and connection diagrams for the remote I/O modules that can be used in MELSEC-I/O LINK systems

Input Specifications

Type	Input Method	Number of Points	Insulation Method	Rated Input Voltage	Input Current	Operating Voltage		Input Response		Input Display	External Connection	Common Connection	Internal Current Consumption (24 VDC)	Number of Occupied Stations
						ON Voltage Current	OFF Voltage Current	OFF → ON	ON → OFF					
AJ55TB3 4D	DC input (sink/source)	4 points	Photocoupler insulation	24 VDC	7 mA	14 V or greater 3.5 mA or greater	6 V or less 1.7 mA or less	10 msec or less	10 msec or less	LED display	Terminal block	4 points per common	35 mA	1 station
AJ55TB3-8D		8 points										8 points per common	45 mA	2 stations
AJ55TB32 4DT *	DC input (sink)	2 points										2 points per common	40 mA	1 station
AJ55TB32-8DT *		4 points										4 points per common	50 mA	
AJ55TB32 4DR *	DC input (sink/source)	2 points										2 points per common	40 mA	
AJ55TB32 8DR *		4 points										4 points per common	50 mA	

Output Specifications

Type	Output Method	Number of Points	Insulation Method	Rated Load Voltage	Maximum Load Current		Output Response Time		Output Display	External Connection	Common Connection	Surge Suppressor	Fuse	Internal Current Consumption	Number of Occupied Stations
					1 Point	1 Common	OFF → ON	ON → OFF							
AJ55TB2 4T	Transistor output (sink)	4 points	Photocoupler insulation	12/24 VDC	0.5 A	2 A	2 msec or less	2 msec or less	LED display	Terminal block	4 points per common	Zener diode	None	45 mA	1 station
AJ55TB2-8T		8 points				4 A					8 points per common			55 mA	2 stations
AJ55TB2-4R	Contact output	4 points		240 VAC 24 VDC	2 A	8 A	10 msec or less	12 msec or less			4 points per common	None		50 mA	1 station
AJ55TB2 8R		8 points									8 points per common			65 mA	2 stations
AJ55TB32-4DT *	Transistor output (sink)	2 points		24 VDC	0.5 A	1 A	2 msec or less	2 msec or less			2 points per common	Zener diode		40 mA	1 station
AJ55TB32-8DT *		4 points				2 A					4 points per common			50 mA	
AJ55TB32-4DR *	Contact output	2 points	240 VAC 24 VDC	2 A	4 A	10 msec or less	12 msec or less	2 points per common	None	40 mA					
AJ55TB32-8DR *		4 points						8 A		4 points per common	50 mA				

* The AJ55TB32-[][] is an I/O combination module
An AJ55TB32-8[][] with one occupied station can use four input and four output points

AJ55TB32 4DR

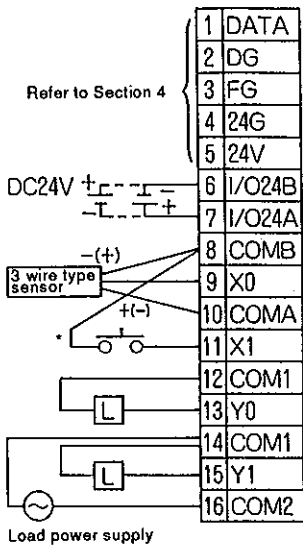

* Connect a 2-wire type sensor to COMB

AJ55TB32 8DR

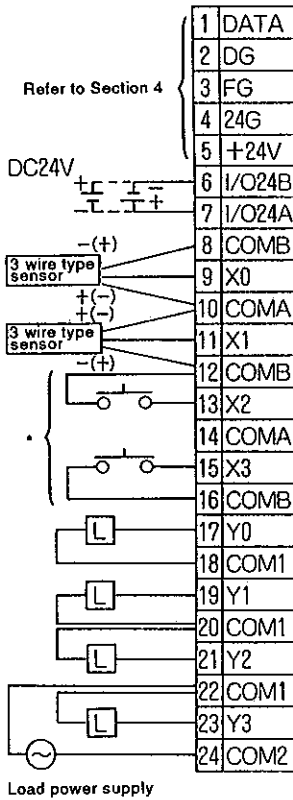

* Connect a 2-wire type sensor to COMB

7. OUTSIDE DIMENSIONS

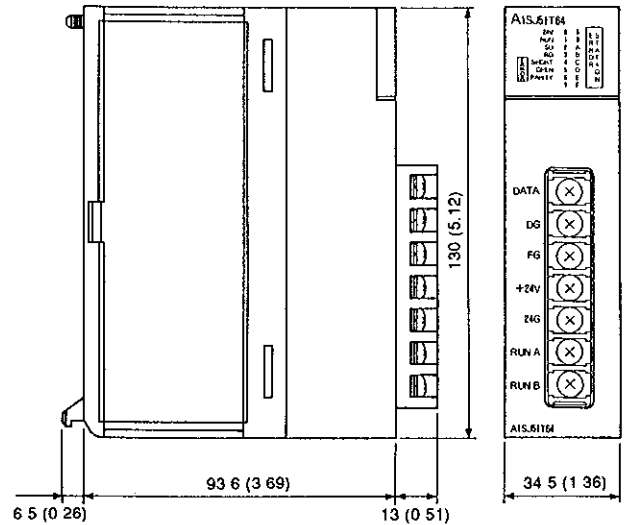

Unit mm (inch)

REVISIONS

A	
Jun., 1995	

IMPORTANT

- (1) Design the configuration of a system to provide an external protective or safety interlocking circuit for the CPs
- (2) The components on the printed circuit boards will be damaged by static electricity, so avoid handling them directly. If it is necessary to handle them take the following precautions
 - (a) Ground human body and work bench
 - (b) Do not touch the conductive areas of the printed circuit board and its electrical parts with and non-grounded tools etc

Under no circumstances will Mitsubishi Electric be liable or responsible for any consequential damage that may arise as a result of the installation or use of this equipment

All examples and diagrams shown in this manual are intended only as an aid to understanding the text, not to guarantee operation. Mitsubishi Electric will accept no responsibility for actual use of the product based on these illustrative examples

Owing to the very great variety in possible applications of this equipment you must satisfy yourself as to its suitability for your specific application